

# Desk Insert Accessories

User Guide

**Branch**

# The new way of working you've been waiting for.

Scan here for a digital copy  
of your assembly guide.





# Caution

- Do not change the specifications or modify this product for any other purpose beyond its intended use.
- Never sit, stand on, or hang from the Desk Insert Accessories.
- Do not place more than the recommended weights onto the Desk Insert Accessories.
- If any parts are missing, broken, damaged, or worn, stop use of these items until Branch authorized replacement parts are received.
- Be careful to ensure items fit firmly on or are securely attached to the Insert Accessories, items on are placed at your own risk.
- Be careful when securing cords with the Cord Screw, organize cords at your own risk.
- Failure to follow these warnings may result in serious injury or death.
- Keep this manual for future reference.

# Desk Insert Accessories

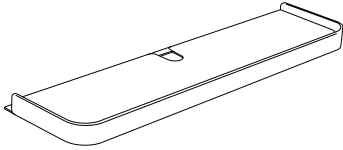

Desk Tray  
Large

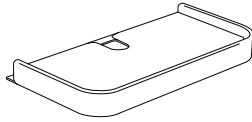

Desk Tray  
Small

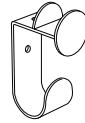

Desk  
Hook

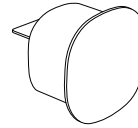

Headphone  
Stand



Cord Screw  
(Included)

## Compatibility:

The Desk Insert Accessories are compatible only with Branch's **Duo Desk** and **Daily Desk**, and attach to the **side edges**

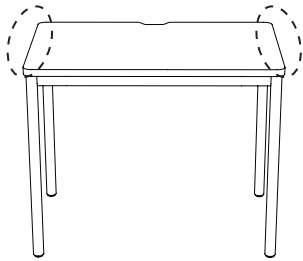

**Daily Desk**

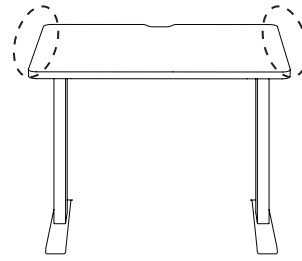

**Duo Desk**

# Weight Limits

## Desk Tray - Large

Weight Limit (distributed)

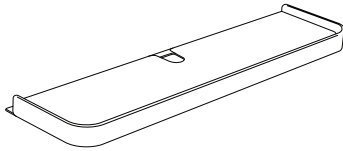

5 lbs / 2.25 kg

## Desk Hook

Weight Limit (distributed)

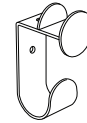

7 lbs / 3.15 kg

## Desk Tray - Small

Weight Limit (distributed)

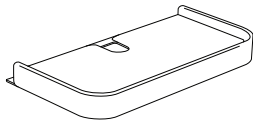

5 lbs / 2.25 kg

## Headphone Stand

Weight Limit (distributed)

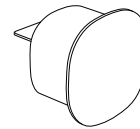

7 lbs / 3.15 kg

# Desk Tray - Large

## Attachment Locations

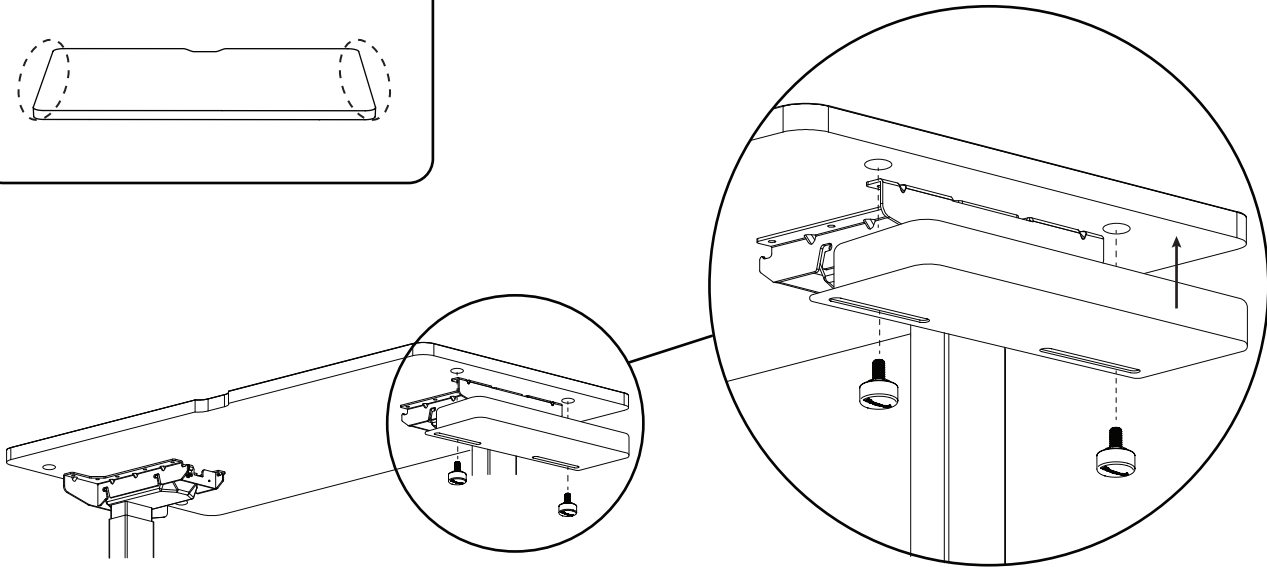
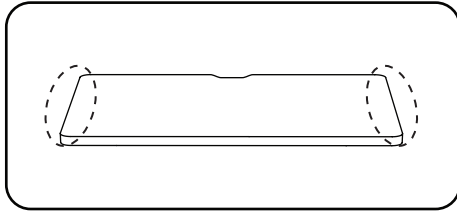

Using the included **Cord Screws** (x2) securely hand tighten your **Desk Tray - Large** into the underside edge of your desk. The **Desk Tray - Large** can be attached to the right or left side of your desk.

# Desk Tray - Small

## Attachment Locations

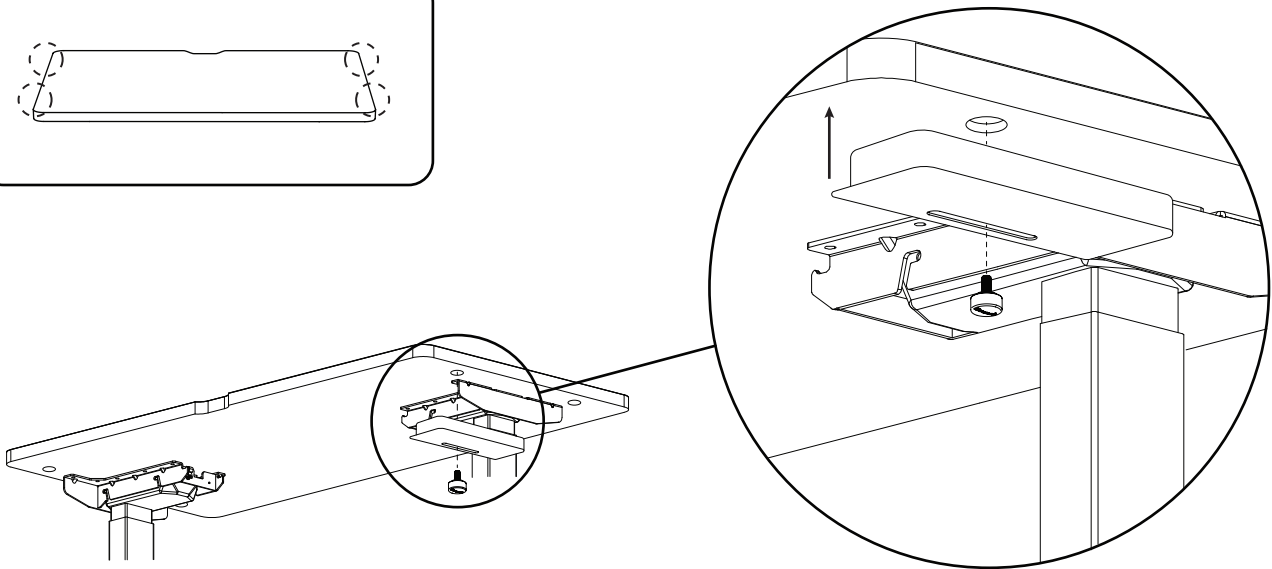
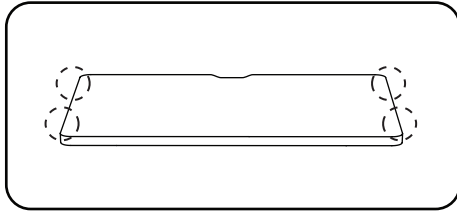

Using the included **Cord Screw** (x1), securely hand tighten your **Desk Tray - Small** into the underside edge of your desk. The **Desk Tray - Small** can be attached in the front or rear insert on either the right and left sides of your desk.

# Desk Hook

## Attachment Locations

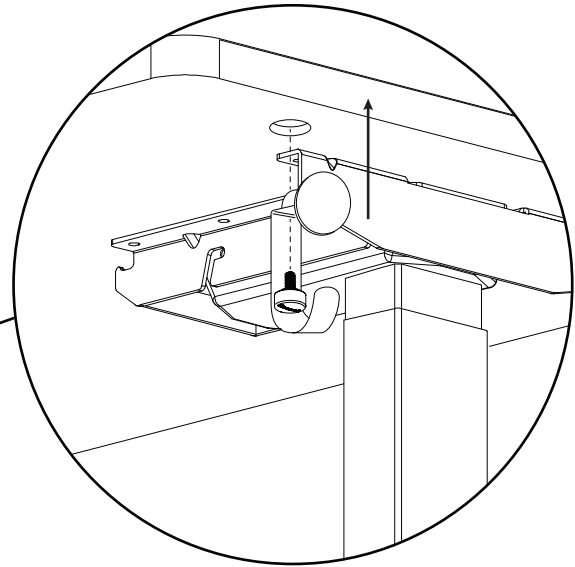
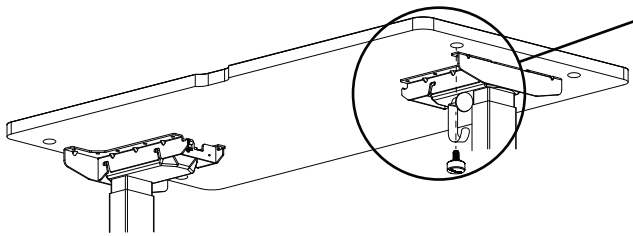
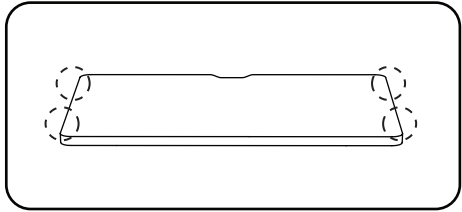

Using the included **Cord Screw** (x1), securely hand tighten your **Desk Hook** into the underside edge of your desk. The **Desk Hook** can be attached in the front or rear insert on either the right and left sides of your desk.



# Headphone Stand

## Attachment Locations

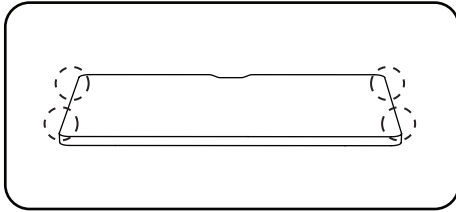

## Tools

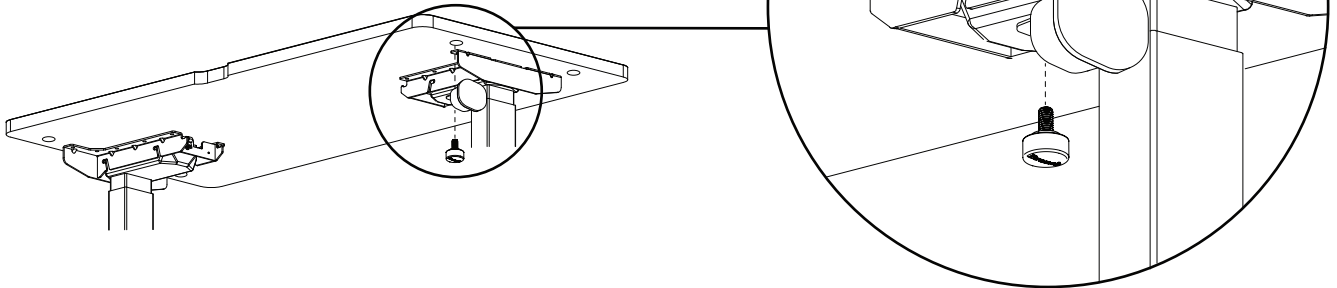
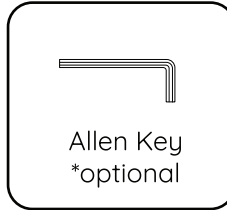

Using the included **Cord Screw** (x1), securely hand tighten your **Headphone Stand** into the underside edge of your **Daily Desk** or **Duo Desk**. The **Headphone Stand** can be attached in the front or rear insert on either the right and left sides of your desk.

# Headphone Stand (optional)

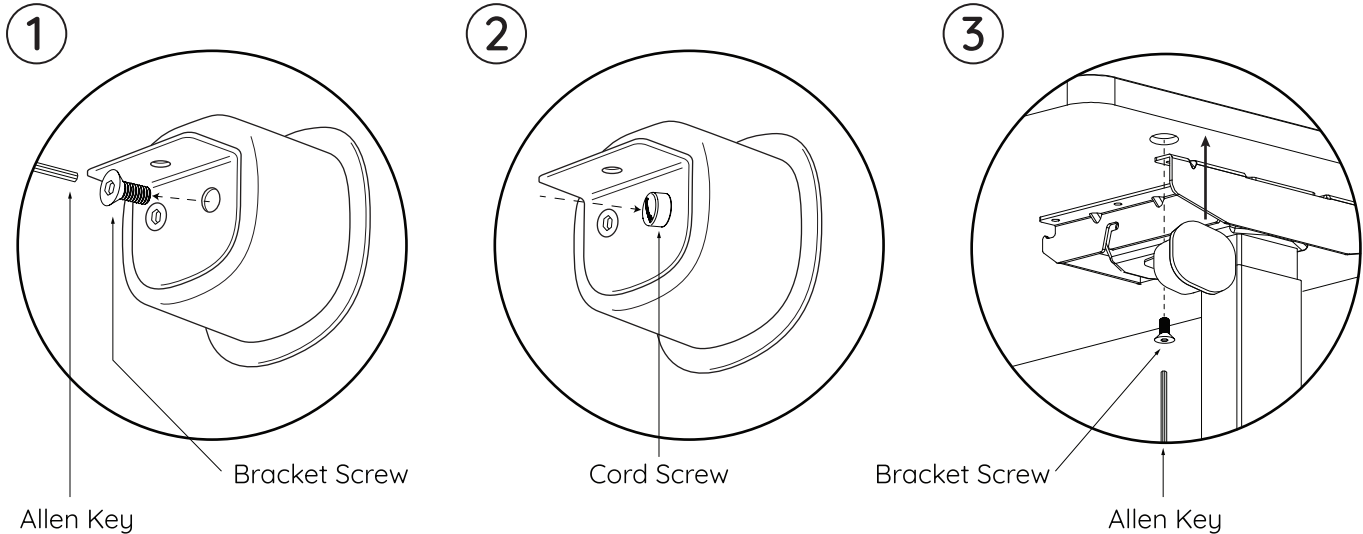

If a tighter fit to the desktop is desired, utilize the included **Allen Key** to unscrew one of the **Bracket Screws** (x2) located on the back of the **Headphone Stand**. Next, screw in the **Cord Screw** (x1) into the empty bracket hole. Finally, use the included **Allen Key**, and the **Bracket Screw** removed from the **Headphone Stand**, to securely attach the **Headphone Stand** into the underside edge of your desk.

# Cord Screw

①

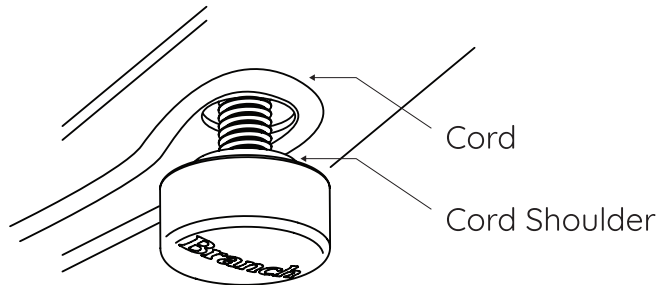

②

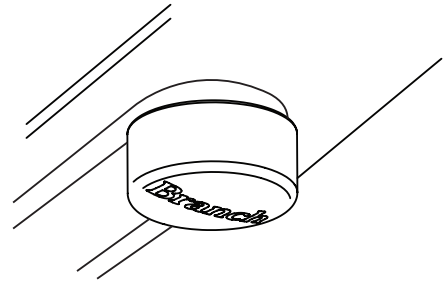

The **Cord Screws** can also be used to organize smaller cords along the underside of your desk surface. Prior to fully tightening, insert your cord into the **Cord Shoulder** and carefully tighten against the desk to capture your cord and insert accessory.

# Contact

Have a question, comment, or suggestion?

hello@branchfurniture.com  
branchfurniture.com

# Branch